

3.1 Power Derating Curve:

Temperature Range: $-55^{\circ}\text{C} \sim +155^{\circ}\text{C}$

If the ambient temperature exceeds 70 degrees centigrade to 155 degrees centigrade, the power can be modified by the curve as below

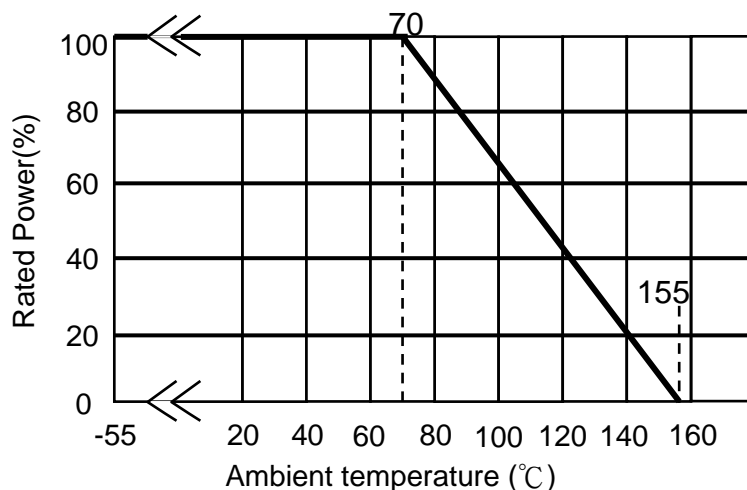

3.2 Voltage Rating:

Rated Voltage: DC voltage or AC voltage (rms) based on the rated power.

The voltage can be calculated by the following formula. If the calculated value exceeds the Max. voltage specified in the Table 3, the Max. voltage rating is set as the voltage rating.

$$E = \sqrt{R \times P}$$

E= Voltage rating (V)
P= Power rating (W)
R= Nominal resistance(Ω)

Remark

IT'S NOT UNDER CONTROL FOR PDF FILE
PLS NOTE THE VERSION STATED..

Issue Dep. DATA Center.

Do not copy without permission

Series No. **60**

4 Dimensions:

Unit:mm

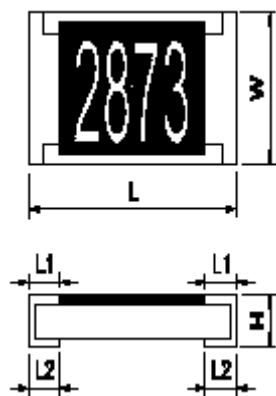

Dimension		L	W	H	L1	L2
Type	Size Code					
RAH02	0402	1.00±0.10	0.50±0.05	0.30±0.05	0.20±0.10	0.25±0.10
RAH03	0603	1.55±0.10	0.80±0.10	0.45±0.10	0.30±0.15	0.30±0.15
RAH05	0805	2.00±0.10	1.25±0.10	0.50±0.10	0.35±0.20	0.35±0.20
RAH06	1206	3.05±0.10	1.55±0.10	0.50±0.10	0.45±0.20	0.35±0.20
RAH12	1210	3.05±0.10	2.55±0.10	0.55±0.10	0.50±0.20	0.50±0.20
RAH20	2010	4.95±0.20	2.45±0.10	0.70±0.10	0.65±0.20	0.60±0.20
RAH25	2512	6.40±0.20	3.20±0.20	0.70±0.10	0.60±0.20	1.25±0.20

5 Structure Graph:

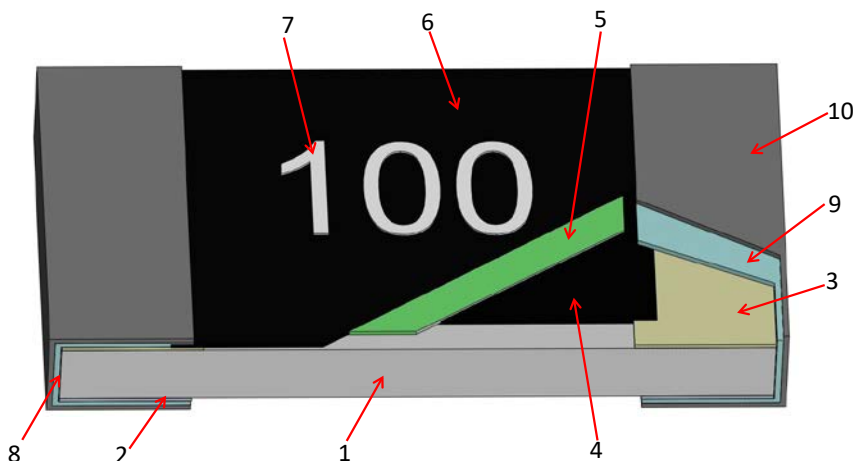

1	Ceramic substrate	6	2nd Protective coating
2	Bottom inner electrode	7	Marking
3	Top inner electrode	8	Terminal inner electrode
4	Resistive layer	9	Ni plating
5	1st Protective coating	10	Sn plating

Remark

IT'S NOT UNDER CONTROL FOR PDF FILE
PLS NOTE THE VERSION STATED..

Issue Dep. DATA Center.

Do not copy without permission

Series No. **60**

6 Reliability Test:

Item	Conditions	Specifications
		Resistors
High Temperature Exposure (Storage)	Put the specimens in the chamber with temperature of 155±3℃ for 1000 hours. Then take them out to stabilize in room temperature for 24±4hr or more, and measure of its resistance variance rate. Experiment evidence: AEC-Q200	0.1%、0.5%、1% : ΔR%=±1.0% 5% : ΔR%=±2.0%
Temperature Cycling	Put the specimens in the High & low temperature test chamber with temperature varies from -55℃ to 125℃ for 15 minutes and total 1000 cycles. Then take them out to stabilize in room temperature for 24±4hr or more, and measure of its resistance variance rate. Experiment evidence: AEC-Q200	0.1%、0.5%、1% : ΔR%=±1.0% 5% : ΔR%=±2.0%
Short Time Overload	Applied 2.5 times rated voltage for 5 seconds and release the load for about 30 minutes, then measure its resistance variance rate. (Rated voltage refers to item 3. general specifications) Refer to JIS-C5201-1 4.13	0.1%、0.5%、1% : ΔR%=±1.0% 5% : ΔR%=±2.0%
Biased Humidity	Solder the specimens on the test PCB and put them into the constant temperature humidity chamber with 85±2℃ and 85±5%RH. Then apply the test voltage that calculates based on the 10% of rated power for 1000hrs. Then take them out to stabilize in room temperature for 24±4hr or more, and measure of its resistance variance rate. Experiment evidence: AEC-Q200	0.1%、0.5%、1% : ΔR%=±2.0% 5% : ΔR%=±3.0%
Operational Life	Solder the specimens on the test PCB and Put them in the chamber with temperature of 125±3℃ and load the voltage for 1000 hours. Then take them out to stabilize in room temperature for 24±4hr or more, and measure of its resistance variance rate. Note: The input voltage shall refer to the power de-rating curve (referring to page 2, No.3.2) Experiment evidence: AEC-Q200	0.1%、0.5%、1% : ΔR%=±2.0% 5% : ΔR%=±3.0%
Board Flex (Bending Test)	Solder the specimens on the test PCB and put the PCB onto the Bending Tester. Add force at the central part of PCB, and the duration of the applied forces shall be 60 (+ 5) Sec. Measure of its resistance variance rate in load. Bending depth D:0402、0603、0805=5mm 1206、1210=3mm 2010、2512= 2mm Experiment evidence: AEC-Q200	0.1%、0.5%、1% : ΔR%=±1.0% 5% : ΔR%=±2.0% No mechanical damage, peel-off of side end or chip crack.

Remark

IT'S NOT UNDER CONTROL FOR PDF FILE
PLS NOTE THE VERSION STATED..

Issue Dep. DATA Center.

Do not copy without permission

Series No. **60**

Item	Conditions	Specifications
		Resistors
Resistance to Soldering Heat	The specimens are fully immersed into the Pb-free solder pot, then take them out to stabilize for 1 hour or more and measure of its resistance variance rate. Temp of solder pot : 260±5℃ Soldering duration : 10±1sec. Experiment evidence AEC-Q200	0.1%、0.5%、1% : ΔR%=±1.0% 5% : ΔR%=±2.0%
ESD	Put the specimens on the test fixture and two (2)discharges (2KVDC) shall be applied to each PUT, one (1) with a positive polarity and one (1) with a negative polarity. Afterwards, the specimens stabilize for 30min or more and measure of its resistance variance rate. The test is performed with direct contact and regular discharge mode. The resistor and capacitor used on the spearhead is 2000Ω and 150pF respectively. Experiment evidence AEC-Q200	ΔR%=±3.0%
Solderability	Test method: Test item 1 (solder pot test): Method B Precondition: The specimens are subjected to 155℃ dry bake for 4hrs±15min. The specimens are immersed into the flux first, then fully immersed into the solder pot, at a temperature of 235± 5℃ for 5+0/-0.5 sec. Then rinse with water and observe the soldering coverage under the microscope. Test item 2 (Leaching test): Method D The specimens are immersed into the flux first, then fully immersed into the solder pot, at a temperature of 260±5℃ for 30+0/-0.5 sec. Then rinse with water and observe the soldering coverage under the microscope. Experiment evidence AEC-Q200	1.Soldering coverage over 95% 2.At the edge of terminal, the object underneath (e.g. white ceramic) shall not expose.
Electrical Characterization	$TCR (ppm/°C) = \frac{(R2-R1)}{R1(T2-T1)} \times 10^6$ R1: Resistance at room temperature (Ω) R2: Resistance at -55℃ or +125℃ (Ω) T1: Room temperature (℃) T2: Temperature -55℃ or +125℃ Experiment evidence: AEC-Q200	Refer to item 3. General specifications

Remark

IT'S NOT UNDER CONTROL FOR PDF FILE
PLS NOTE THE VERSION STATED..

Issue Dep.**DATA Center.**

Do not copy without permission

Series No. **60**

7 Measurement Point:

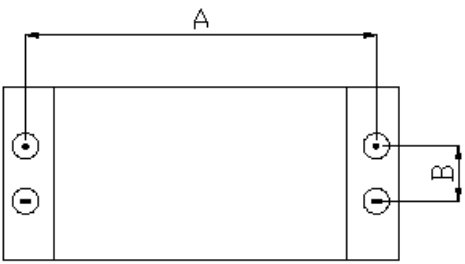
Measure from bottom electrodes		Unit : mm	
 <p>⊙ Current Terminal ⊖ Voltage Terminal</p>	DIM TYPE	A	B
	RAH02	0.80±0.05	0.24±0.05
	RAH03	1.35±0.05	0.35±0.05
	RAH05	1.80±0.05	0.35±0.05
	RAH06	2.90±0.05	0.35±0.05
	RAH12	2.90±0.05	0.35±0.05
	RAH20	4.50±0.05	1.15±0.05
	RAH25	5.90±0.05	1.60±0.05

8 Plating Thickness:

8.1 Ni: ≥2μm

8.2 Sn(Tin): ≥3μm

8.3 Sn(Tin): Matte Sn

9 Rule of package empty quantity:

Empty quantity for each reel is not allowed to exceed 0.1% of the whole quantity, and continuous 2pcs (included) empty are also unallowed.

Remark

IT'S NOT UNDER CONTROL FOR PDF FILE
PLS NOTE THE VERSION STATED..

Issue Dep. DATA Center.

Do not copy without permission

Series No. **60**

10 Technical application notes: (This is for recommendation, please customer perform adjustment according to actual application)

10.1 Recommend Soldering Method:

10.1.1 Lead Free IR Reflow Soldering Profile (MEET J-STD-020D)

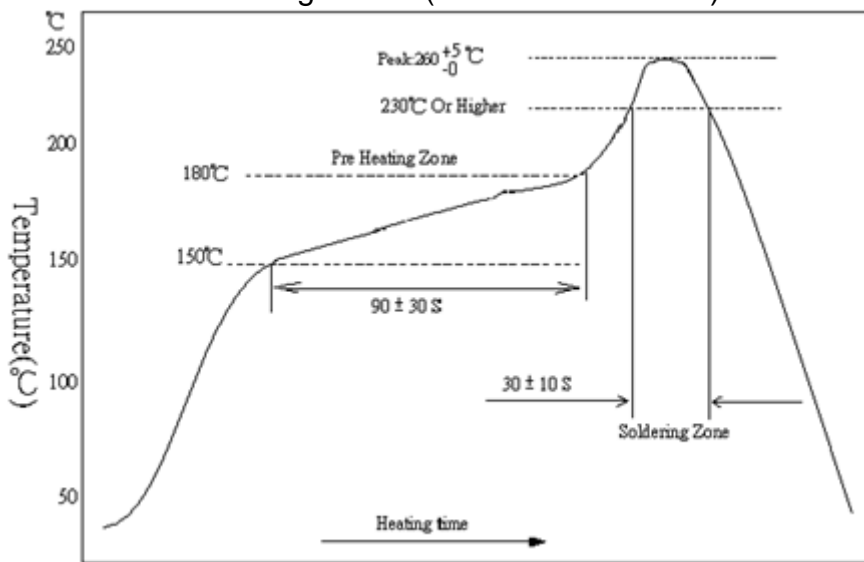

Remark: The peak temperature of soldering heat is 260 +5/-0 °C for 10 seconds.

10.1.2 Lead Free Double-Wave Soldering Profile. (This applies to 0603 and above size products)

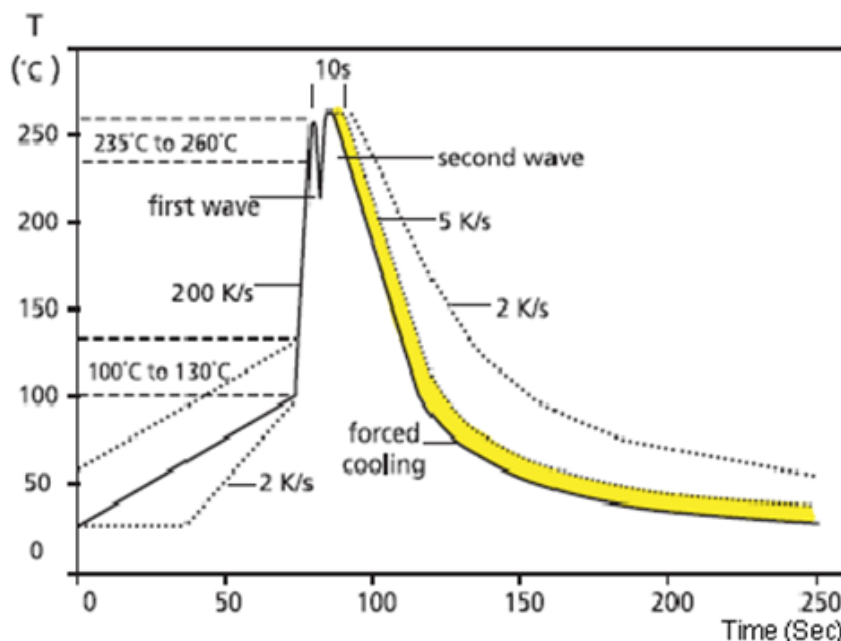

10.1.3 Soldering Iron: temperature 350°C ± 10°C , dwell time shall be less than 3 sec.

Remark

IT'S NOT UNDER CONTROL FOR PDF FILE
PLS NOTE THE VERSION STATED..

Issue Dep. DATA Center.

Do not copy without permission

Series No. **60**

10.2 Recommend Land Pattern Design (For Reflow Soldering)

When a component is soldered, the resistance after soldering changes slightly depending on the size of the soldering area and the amount of soldering. When designing a circuit, it is necessary to consider the effect of a decrease or increase in its resistance.

Unit:mm

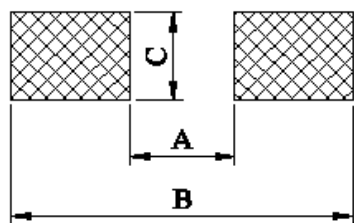

TYPE \ DIM	A	B	C
RAH02	0.5	1.5	0.6
RAH03	0.8	2.1	0.9
RAH05	1.2	3.0	1.3
RAH06	2.2	4.2	1.6
RAH12	2.2	4.2	2.8
RAH20	3.5	6.1	2.8
RAH25	3.8	8.0	3.5

10.3 Automobile Electronic Application:

This specification is for automobile electronic use. RALEC will take no responsibility if any damage, cost or loss occurs when the product has been used in any special circumstances.

- (a) Information 、 entertainment 、 navigation 、 audio control units.
- (b) Comfortable door, window, seat control unit.
- (c) Internal lighting control unit.

10.4 Environment Precautions:

If consumer intends to use our company product in special environment or condition (including but not limited to those mentioned below), then will need to make individual recognition of product features and reliability accordingly.

- (a) Used in high temperature and humidity environment
- (b) Exposed to sea breeze or other corrosive gas, such as Cl₂ 、 H₂S 、 NH₃ 、 SO₂ and NO₂.
- (c) Used in non-verified liquids including water, oil, chemical and organic solvents.
- (d) Using non-verified resin or other coating material to seal or coat our Company product.
- (e) After soldering, it is necessary to use water-soluble detergents to clean residual solder fluxes, even though no-clean fluxes are recommended.

Remark

IT'S NOT UNDER CONTROL FOR PDF FILE
PLS NOTE THE VERSION STATED..

Issue Dep. **DATA Center.**

Do not copy without permission

Series No. **60**

RALEC 旺詮	RAH Series Thick Film Chip Resistors Product Specification(Automotive Grade)	Document No.	IE-SP-110
		Released Date	2021/07/15
		Page No.	9

10.5 Momentary Overload Precautions:

The product might be out of function when momentary overloaded. Please make sure to avoid momentary overloading while using and preserving.

10.6 Operation and Processing Precautions:

- (a) Avoid damage to the edge of resistor and protective layer caused by mechanical stress.
- (b) Handle with care when printing circuit board (PCB) is divided or fixed on support body, because bending of printing circuit board (PCB) mounting will make mechanical stress for resistors.
- (c) Make sure the power rating is under the limit when using the resistor. When power rating is over the limit, the resistor will be overloaded. There might be machinery damage due to the climbing temperature
- (d) If the resistor will be exposed under massive impact load (shock wave) in a short period of time, the working environment must be set up well before use.
- (e) Please make evaluation and confirmation when the product is well used in your company and have a through consideration of its fail-safe design to ensure the system safety.



Remark	IT'S NOT UNDER CONTROL FOR PDF FILE PLS NOTE THE VERSION STATED..	Issue Dep. DATA Center.
	Do not copy without permission	Series No. 60

RALEC 旺詮	RAH Series Thick Film Chip Resistors Product Specification(Automotive Grade)	Document No.	IE-SP-110
		Released Date	2021/07/15
		Page No.	10

11 Storage and transportation requirement:

- 11.1 The temperature condition must be controlled at $25\pm 5^{\circ}\text{C}$, the R.H. must be controlled at $60\pm 15\%$. The stock can maintain quality level in two years.
- 11.2 Please avoid the mentioned harsh environment below when storing to ensure product performance and its' weldability. Places exposed to sea breeze or other corrosive gas, such as Cl_2 、 H_2S 、 NH_3 、 SO_2 and NO_2 .
- 11.3 When the product is moved and stored, please ensure the correct orientation of the box. Do not drop or squeeze the box. Otherwise, the electrode or the body of the product may be damaged.

12 The carton packaged for electronic-information products is made by the symbol as follows: (For china)

	
Marking for control of pollution cause by electronic-information products	Marking for package recovery

13 Attachments:

- 13.1 Document Revise Record (QA-QR-027)

Remark	IT'S NOT UNDER CONTROL FOR PDF FILE PLS NOTE THE VERSION STATED..	Issue Dep. DATA Center.
	Do not copy without permission	Series No. 60

RALEC 旺詮	RAH Series Thick Film Chip Resistors Product Specification(Automotive Grade)	Document No.	IE-SP-110
		Released Date	2021/07/15
		Page No.	11

Legal disclaimer

RALEC, its distributors and agents (collectively, "RALEC"), hereby disclaims any and all liabilities for any errors, inaccuracies or incompleteness contained in any product related information, including but not limited to product specifications, datasheets, pictures and/or graphics. RALEC may make changes, modifications and/or improvements to product related information at any time and without notice.

RALEC makes no representation, warranty, and/or guarantee about the fitness of its products for any particular purpose or the continuing production of any of its products. To the maximum extent permitted by law, RALEC disclaims (i) any and all liability arising out of the application or use of any RALEC product, (ii) any and all liability, including without limitation liability for any loss of profits or for direct, indirect, special, punitive, consequential or incidental damages arising out of or related to RALEC products, and (iii) any and all implied warranties, including warranties of fitness for a particular purpose, non-infringement and merchantability.

RALEC defined this product is for automotive electronic use , not design for any application for medical life-saving or life support equipment, or any application which may inflict casualties if RALEC product failure occurred. Any and all technical advice furnished by RALEC with reference to the use of RALEC products are given free of charge and RALEC assumes no obligation or liability for the advice given or results obtained, and all such advice are given and accepted at buyer's risk. Buyer shall assume all risk and liability for the results obtained by the use of any RALEC products in combination with other articles or material or in the practice of any process, regardless of any oral or written technical statement made by RALEC with respect to the use of such products by way of technical advice or otherwise. Further, buyer represents and warrants that it has the experience and capacity of determining the correct product for its intended application.

Information provided here is intended to indicate product specifications only. RALEC reserves all the rights for revising this content without further notification, as long as products are unchanged. Any product change will be announced by ECN.

Remark	IT'S NOT UNDER CONTROL FOR PDF FILE PLS NOTE THE VERSION STATED..	Issue Dep. DATA Center.
	Do not copy without permission	Series No. 60