

WRC SERIES

- POWER TYPE WIRE WOUND CEMENT RESISTOR WITH GLASS ROD → WGR
- POWER TYPE WIRE WOUND CEMENT RESISTOR WITH CERAMIC ROD → WCR
- POWER TYPE CEMENT RESISTOR WITH METAL OXIDE FILM RESISTOR → WMR

■ R-TYPE

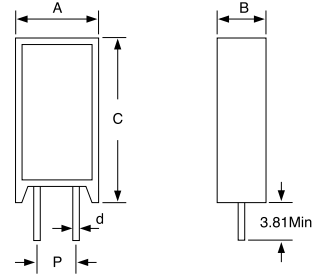
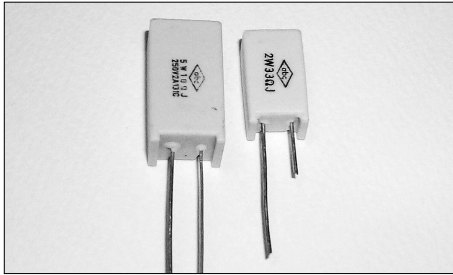

Type	Power Rating	Resistance Range		Dimensions(mm)				
		E-24-J(±5%) or G(±2%)		A ± 1.0	B ± 1.0	C ± 1.0	P ± 1.0	d
		WCR	WMR					
WRC 2R	2W	0.1-20	20-100K	11	7.5	20.5	5.0	0.8
WRC 3R	3W	0.1-20	20-100K	11	7.5	20.5	5.0	0.8
WRC 5R	5W	0.1-50	50-100K	12.7	10	25.4	5.0	0.8
WRC 7R	7W	0.1-100	100-100K	12.7	10	38.6	5.0	0.8

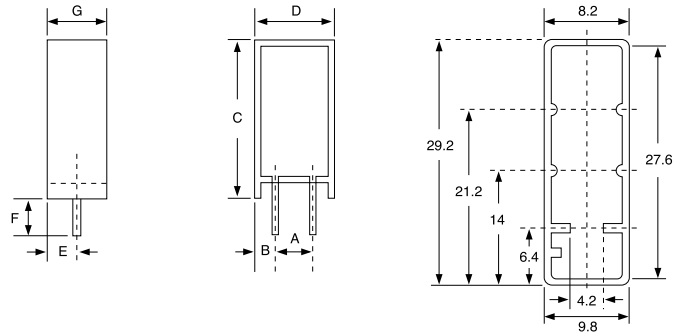
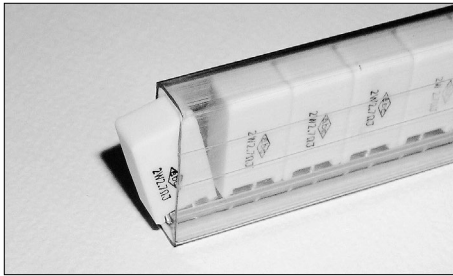

■ RT-TYPE

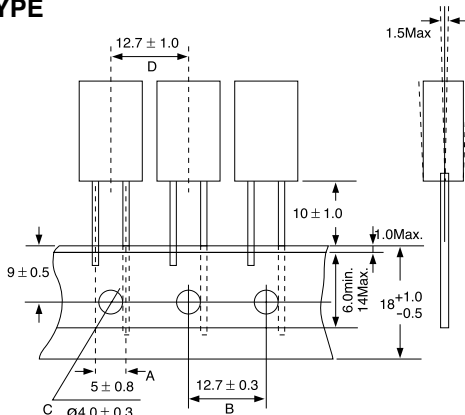

■ STICK CASE

W×H×L(mm)	9.8×29.2×580	Remarks
Qty(PCS)	50	2W,3W
	40	5W

■ DIMENSIONS

	Unit: mm						
	A ± 0.2	B ± 0.2	C ± 1	D ± 0.5	E ± 0.3	F ± 0.5	G ± 0.5
2RT	5.0	3.0	20.5	11.0	3.5	4.5	7.5
3RT	5.0	3.0	20.5	11.0	3.5	4.5	7.5

■ P-TYPE

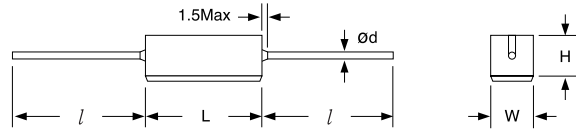
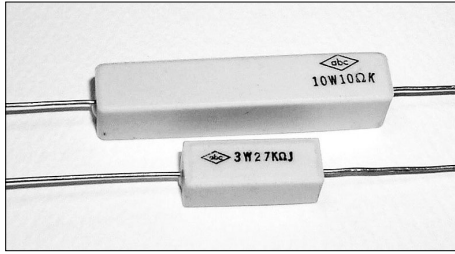

Type	Power Rating	Resistance Range			Dimensions(mm)				
		J(±5%), G(±2%) or F(±1%)			L ± 1.5	ø ± 3	W ± 1.0	H ± 1.0	d
		WGR	WCR	WMR					
WRC 2P	2W	0.1~20	0.1~20	20-100K	17.5	27	6.4	6.4	0.8
WRC 3P	3W	0.1~20	0.1~20	20-100K	22	25	8.0	8.5	0.8
WRC 5P	5W	0.1~30	0.1~30	30-100K	22	25	9.5	9.5	0.8
WRC 7P	7W	0.1~50		50-100K	35	25	9.5	9.5	0.8
WRC 10P	10W	0.1~300		300-100K	48	25	9.5	9.5	0.8
WRC 15P	15W	0.1~500		500-100K	48	25	12.5	12.5	0.8
WRC 20P	20W	0.1~600		600-100K	63	25	12.5	12.5	0.8

■ MS-TYPE

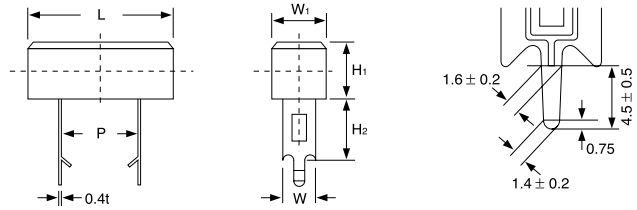
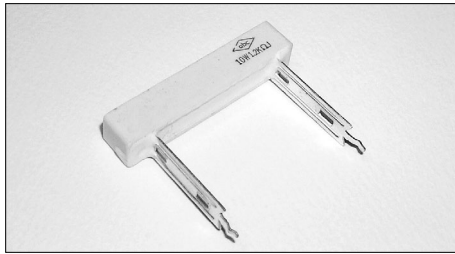

Type	Power Rating	Resistance Range	Dimensions(mm)					
		J(±5%) or F(±1%)	L ± 1	P ± 1	W1 ± 0.5	W2 ± 0.5	H1 ± 1	H2 ± 1
WRC 5MS	5W	0.1~100K	27	10/15	9.5	5/7.5	9.5	15
WRC 7MS	7W	0.1~100K	35	20/22.5	9.5	5/7.5	9.5	15
WRC 10MS	10W	0.1~100K	48	30/35	9.5	5/7.5	9.5	15
WRC 15MS	15W	0.1~100K	48	35	12.5	5/7.5	12.5	15
WRC 20MS	20W	0.1~100K	62.5	45	13.5	5/7.5	12.5	15

■ MD-TYPE

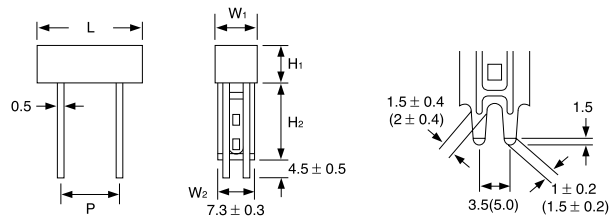
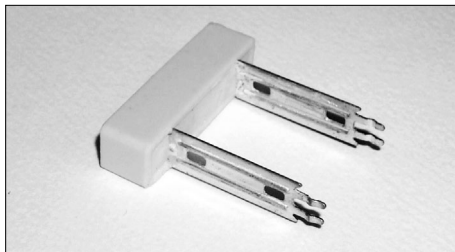

Type	Power Rating	Resistance Range	Dimensions(mm)					
		J(±5%) or F(±1%)	L ± 1	P ± 1	W1 ± 1	W2 ± 1	H1 ± 1	H2 ⁺² ₋₁
WRC 5MD	5W	0.1~100K	27	15	9.5	7.3	9.5	15
WRC 7MD	7W	0.1~100K	35	22.5	9.5	7.3	9.5	15
WRC 10MD	10W	0.1~100K	48	35	9.5	7.3	9.5	15

WRC SERIES

■ L(LUG-TYPE)

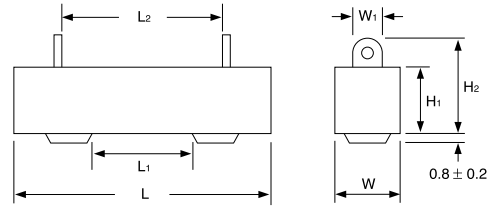

Type	Power Rating	Resistance Range			Dimensions(mm)						
		J(±5%)			L ± 1.5	L1 ± 1.2	L2 ± 1.2	W ± 0.6	W1	H1 ± 0.7	H2 ± 1.7
WRC 10L	10W	0.1~100K			48	13	35	9.5	6	9.5	20
WRC 15L	15W	0.1~100K			48	25	35	12.5	6	12.5	20
WRC 20L	20W	0.1~100K			63.5	25	48	12.5	6	12.5	20
WRC 25L	25W	0.1~100K			63.5	25	48	16	6/7.5	15.7	24/28

■ LA-TYPE

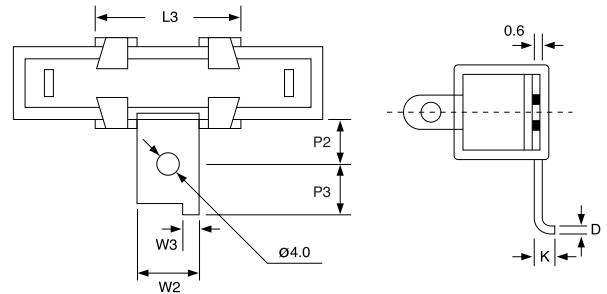
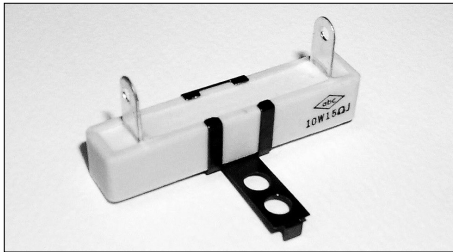

Type	Power Rating	Resistance Range			Dimensions(mm)						
		J(±5%)			P2	P3	W2	W3	L3	K	D
		WGR	WCR	WMR							
WRC 10LA	10W	0.1~600	0.1~600	600~75K	8.0	6.0 ± 0.5	12	3.0 ± 0.5	24 ± 0.5	2.8 ± 0.3	0.6
WRC 15LA	15W	0.1~800	0.1~800	800~68K							0.8
WRC 20LA	20W	0.1~1K	0.1~800	1K~50K							0.8

■ V-TYPE

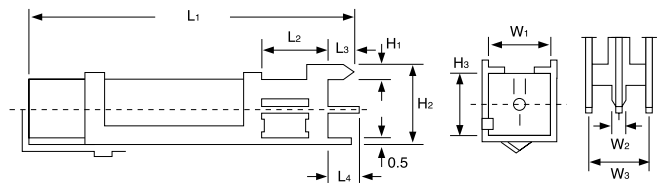
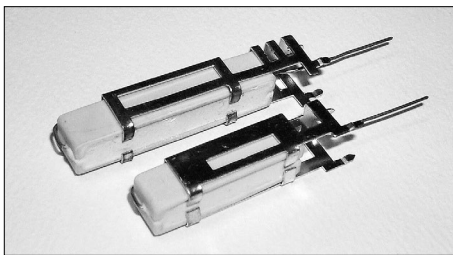

Type	Power Rating	Resistance Range				Dimensions(mm)									
		F(±1%) or J(±5%)				L1 ± 1	L2 ± 1	L3 ± 1	L4 ± 1	H1 ± 1	H2 ± 1	H3 ± 1	W1 ± 1	W2 ± 1	W3 ± 1
WRC 7V	7W	0.1~100K				49	10	4	5	1.5	11	9	9.5	1.5	10
WRC 10V	10W	0.1~100K				62	10	4	5	1.5	11	9	9.5	1.5	10

■ HOW TO ORDER

WRC	5	R	10Ω	J
ABCO Code	Power Rating	Type	Resistance	Tolerance

■ VOLTAGE RATING

Resistor shall have a rated DC or RMS continuous working voltage at commercial line frequency and wave from corresponding to the power rating, as determined from the following formula

$$E = \sqrt{P \times R}$$

E: Rated continuous working voltage
 P: Power rating
 R: Nominal resistance

■ POWER RATING

Resistor shall have a power specified on table and based on continuous full-load operation at an ambient temperature of 75°C for 2W, 40°C for 3W through 10W, 25°C for over wattage.

For resistors operated at an ambient temp. exceeding these specified level, the load shall be derated in accordance with Fig. 1 below.

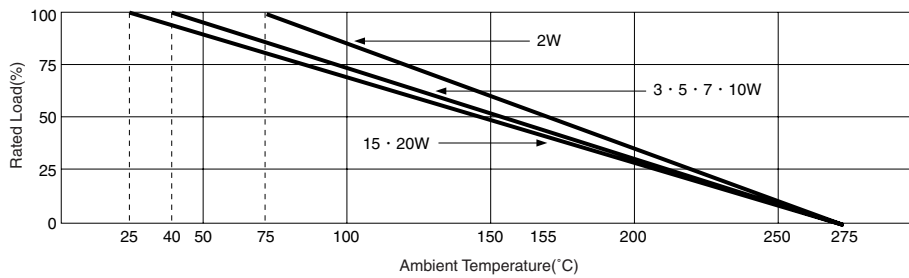

■ SURFACE TEMPERATURE RISE

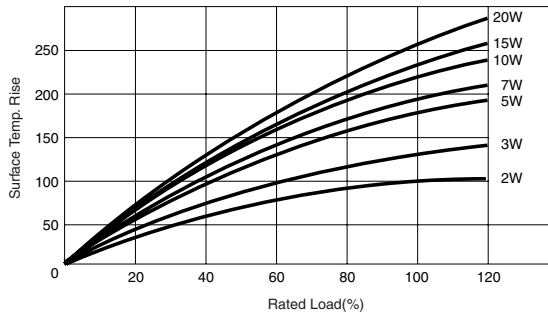

■ PERFORMANCE CHARACTERISTICS

Item	Max. permissible deviation
Operating temp. range	-25°C ~ +155°C
Load life	No mechanical damage ± (5% + 0.05Ω)
Moisture load life	No mechanical damage No arcing or breakdown ± (5% + 0.05Ω)
Dielectric Withstanding voltage	No mechanical damage ± (2% + 0.05Ω)
Thermal shock	No mechanical damage ± (5% + 0.05Ω)
Short time over load	No mechanical damage ± (2% + 0.05Ω)

FIXED RESISTORS